



OPTIMUM DESIGN OF TMD SYSTEM FOR TALL BUILDINGS

A. Abdelraheem Farghaly^{*,†}
Faculty of Industrial Education, Sohag University, Egypt

ABSTRACT

High tall buildings are more susceptible to dynamic excitations such as wind and seismic excitations. In this paper, design procedure and some current applications of tuned mass damper (TMD) were studied. TMD was proposed to study response of 20 storey height building to seismic excitations using time history analysis with and without the TMD.

The study indicates that the response of structures such as storey displacements and shear force of columns can be dramatically reduced by using TMD groups with specific arrangement in the model. The study illustrates the group of four TMDs distributed on the plane can be effective as reinforced concrete core shear wall.

Received: 10 May 2012; Accepted: 20 August 2012

KEY WORDS: TMDs groups, high rise building, vibration control, time history analysis, SAP 2000

1. INTRODUCTION

The application of the passive Tuned Mass Damper (TMD) is an attractive option in reducing excessive floor vibrations. A TMD consists of a mass, spring, and dashpot, as shown in Figure 1, and is typically tuned to the natural frequency of the primary system [1]. When large levels of motion occur, the TMD counteracts the movements of the structural system. The terms m_1 , k_1 , c_1 , X_1 represent the mass, stiffness, damping and displacement of the floor respectively, while m_2 , k_2 , c_2 , X_2 represent the mass, stiffness, damping and displacement of the TMD and $F(t)$ represents the excitation force.

As the two masses move relative to each other, the passive damper is stretched and

*Corresponding author: A. Abdelraheem Farghaly, Lecturer in Faculty of Industrial Education, Sohag University, Egypt

†E-mail address: khodary20002000@yahoo.com (A. Abdelraheem Farghaly)

compressed, reducing the vibrations of the structure through increasing its effective damping.

TMD systems are typically effective over a narrow frequency band and must be tuned to a particular natural frequency.

They are not effective if the structure has several closely spaced natural frequencies and may be increased the vibration if they were off-tuned [2].

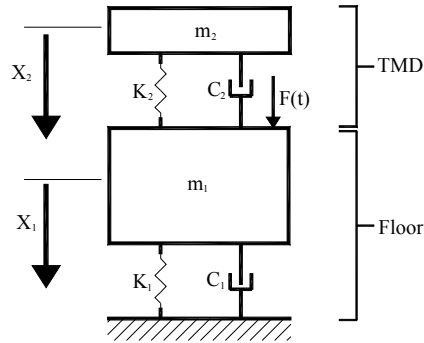

Figure 1. Schematic Representation of a Two DOF System

The natural frequency of the primary system can be divided into lower (f_1) and higher (f_2) frequency by attaching a spring mass tuned to the same fundamental natural frequency (f_n) of the primary system as shown in Figure 2. The most significant design variable of the damper is the mass ratio (μ) as defined in equation 1. When the mass ratio increases, the TMD becomes more effective and robust [3]. In most applications the mass ratio is designed to be in the range of 1-10%.

$$\mu = \frac{m_2}{m_1} \quad (1)$$

In the design of a TMD, the optimum natural frequency of the damper (f_d), and the optimum damping ratio of damper (ζ_{opt}) are given by equation 2 and 3 respectively:

$$f_d = \frac{f_n}{1 + \mu} \quad (2)$$

$$\zeta_{opt} = \sqrt{\frac{3\mu}{8(1 + \mu)^3}} \quad (3)$$

If there is zero damping then resonance occurs at the two un-damped resonant frequencies of the combined system (f_1 & f_2). The other extreme case was occurred when there is infinite damping, which has the effect of locking the spring (k_2). In this case the system has one degree of freedom with stiffness of (k_1) and a mass of ($m_1 + m_2$). Using an intermediate value of damping such as ζ_{opt} , somewhere between these extremes, it is possible to control the vibration of the primary system over a wider frequency range [4].

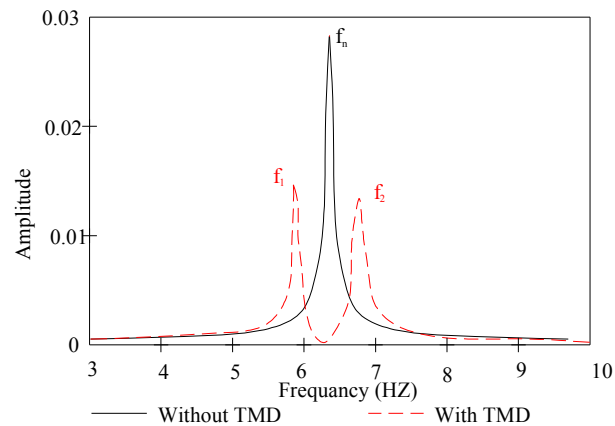

Figure 2. Example Demonstrating the Effectiveness of a TMD

An-Pei and Yung-Hing [5] were concluded that TMD system was effective in reducing the responses of displacement and velocity of the building structure.

Semih, and Ozan [6], examined the application of viscoelastic dampers for three kinds of buildings to reduce earthquake response of them; (a) A 7-storey steel frame, (b) a 10-storey reinforced concrete frame, and (c) a 20-storey reinforced concrete frame. They have concluded that, the numerical results on three example frames clearly indicate that the viscoelastic dampers reduce the seismic response of structures in an extremely efficient way. In addition, it has been seen that the viscoelastic dampers in tall buildings were most effective for high frequency earthquakes like El-Centro, but for low frequency earthquakes loads, the viscoelastic devices were less effective.

The effectiveness of a single TMD was decreased significantly by the off-tuning or the off optimum damping in the TMD i.e. a single TMD is not robust at all. Furthermore, the dynamic characteristics of structures will change under strong earthquakes due to a degradation of the structure stiffness. This change will degrade the performance of a single TMD considerably due to the offset in the tuning of the frequency and/or in the damping ratio. As a result, the utilization of more than one tuned mass damper with different dynamic characteristics has been proposed in order to improve the effectiveness and robustness of a single TMD. Iwanami and Seto [7] proposed dual tuned mass dampers (2TMD) and were conducted a research on the optimum design of 2TMD for harmonically forced vibration of the structure. It was shown that 2TMD are more effective than a single TMD. However, the effectiveness was not significantly improved. Recently, multiple tuned mass dampers (MTMD) with distributed natural frequencies were proposed by Igusa and Xu [8]. They were derived a simple formula of equivalent additional damping and an integral form for the impedance based on an asymptotic analysis technique. Based on the various combinations of the stiffness, mass, damping coefficient and damping ratio in the MTMD, five MTMD models have been presented by Li [9].

The MTMD is shown to be more effective in mitigating the oscillations of structures with respect to a single TMD. These research findings have also confirmed the merit of the MTMD in seismic applications. In terms of installation the merit of the MTMD with respect

to a single TMD is that the MTMD consists of distributed dampers with small mass and generally does not require any devoted space to install them. Engineers can then make full use of the spare space at different floors of the buildings and thus design them in a cost-effective way. Here, it is worth pointing out what we would really see in a practical situation is probably three dimensional (3D) frames a few stories high. That would make the special distribution of the MTMD much harder. However, in such a case, the MTMD with the total number equal to three or five generally is required to be placed on the top floor. Another advantage is that the malfunction of an individual damper, due to its light weight, will not cause detrimental effects on the structural responses so that the MTMD strategy is very robust. Recently, based on the various combinations of the stiffness, mass, damping coefficient, and damping ratio in the MTMD, five MTMD models have been presented by Li [10]. Through implementing the minimization of the minimum values of the maximum displacement dynamic magnification factors and the minimization of the minimum values of the maximum acceleration dynamic magnification factors it has been shown that the MTMD with the identical stiffness and damping coefficient but unequal mass and damping ratio can provide better effectiveness and wider optimum frequency spacing with respect to the rest of the MTMD models [10]. Likewise, the studies by Li and Liu [11] have disclosed further trends of both the optimum parameters and effectiveness and further provided suggestion on selecting the total mass ratio and total number of the MTMD with the identical stiffness and damping coefficient but unequal mass and damping ratio. More recently, in terms of the uniform distribution of system parameters, instead of the uniform distribution of natural frequencies, eight new MTMD models have been proposed to seek for the MTMD models without the near-zero optimum average damping ratio. Six MTMD models without the near-zero optimum average damping ratio have been found. The optimum MTMD with the identical damping coefficient and damping ratio but unequal stiffness and with the uniform distribution of masses has been found able to render better effectiveness and wider optimum frequency spacing with respect to the rest of the MTMD models [12]. Likewise it is interesting to know that the two above mentioned MTMD models can approximately reach the same effectiveness and robustness [12].

Sadek et al. [13] found that the tuning ratio , f , in equation 4 for a MDOF system is nearly equal to the tuning ratio for a SDOF system for the mass ratio of $\mu\Phi$, where Φ is the amplitude of the first mode of vibration for a unit model participation factor computed at the location of the TMD, i.e. $f_{\text{MDOF}}(\mu) = f_{\text{SDOF}}(\mu\Phi)$.

$$f = \frac{1}{1 + \mu\Phi} \left[1 - \beta \sqrt{\frac{\mu\Phi}{1 + \mu\Phi}} \right] \quad (4)$$

The TMD damping ratio is also found to correspond approximately to the damping ratio computed for a SDOF system multiplied by Φ , i.e. $\zeta_{\text{MDOF}}(\mu) = \Phi\zeta_{\text{SDOF}}(\mu)$ and damping is given by equation 5.

$$\zeta = \Phi \left[\frac{\beta}{1 + \mu} + \sqrt{\frac{\mu}{1 + \mu}} \right] \quad (5)$$

The above equation indicates that the best location for TMD is at the largest ζ , i.e. at the level where Φ and consequently the damping in the TMD and in the first two modes are maximums. Since in most cases, the first mode dominates the response, it is the largest. Similar observations have also been reported by Villaverde [14].

Table (1) shows the application of the above equations on 3, 6, and 10 storey building. The optimum values of f and ζ for the three structures are given in table (1) along with the resulting damping ratios in the first two modes of vibration. As shown in table (1), the damping ratios are extremely close to each other and are greater than $(\zeta+\beta)/2$. It should be mentioned that the TMDs attached to the structures affected only the damping in the first two modes and had no effect on the other modes which were assumed to have a zero damping [13].

Table 1. Optimum TMD parameters for the three MDOF structures [13]

No. of storey	μ	β	f	ζ	ζ_1	ζ_2	$(\zeta_1+\zeta_2)/2$	Φ
10	0.05	0.02	0.93	0.33	0.18	0.18	0.17	1.36
6	0.08	0.05	0.91	0.41	0.24	0.24	0.22	1.33
3	0.10	0.00	0.87	0.37	0.20	0.20	0.18	1.23

The best design of any structure is safety, serviceability and economy. Achieving better design of structures in seismic regions is very important and difficult. Uncertainty and unpredictability of when, where and how an earthquake will be happen, will increase the overall difficulties. The goal of this research is studying the seismic behaviour of tall building structures by TMDs.

Finite Element Method (FFM) is a numerical method that can be used to solve different kinds of engineering problems in the stable, transient, linear or nonlinear cases [15]. Among finite element method software's, SAP2000 is known as one of the most precise and practicable software in industry and university researchers. It is used for dynamic analysis such as earthquake and water wave loading on structures.

The optimum parameters used in this paper for TMDs of The optimum frequency ratio α_{opt} , damping ratio ζ , spring stiffness k_d , and damping c_d as Zahrai and ghannadi-Asl [16] are in the equation (6), (7), (8), and (9):

$$\alpha_{opt} = \frac{1}{1+\mu} \sqrt{\frac{2-\mu}{2}} \quad (6)$$

$$\zeta_{opt} = \sqrt{\frac{3\mu}{8(1+\mu)}} \sqrt{\frac{2}{2-\mu}} \quad (7)$$

$$k_d = 4\pi^2 \mu \alpha^2 \frac{m_d}{T_d^2} \quad (8)$$

$$c_d = 4\pi\pi\mu \zeta_{opt} \frac{m_d}{T_d} \quad (9)$$

In Den Hartog's derivation of optimal damper parameters, it is assumed that the main mass is un-damped. In the presence of damping for the main mass, no closed form expressions can be derived for the optimum damper parameters. However, they may be obtained by numerical trials with the aim of achieving a system with the smallest possible value of its higher response peak [16].

2. OBJECTIVES

The objective of this research is to find an alternative method of the traditional method in resisting existing earthquake force and reducing the response of high tall building subject to earthquake force. Accordingly the following steps were performed:

- a) Remodelling of a tall building structure (MRF building) by TMD system.
- b) Determining the effects earthquake generated from El Centro on seismic behaviour of tall buildings.
- c) Study the effect of distributed the TMD on the plan and through the model to give the best distribution in the model.
- d) Using a TMD system as an alternative system to resist the lateral force resulting from an earthquake.

A lateral load resistance system is a tube-in-tube or hull-core structure. It consists of an outer framed tube, the hull together with an internal elevator and service core.

3. MODEL DEFINITION

A twenty storey concrete MRF building ($f_s=2000 \text{ kg/cm}^2$, $f_c=100 \text{ kg/cm}^2$) with specific dimensions as shown in table (2) was tested.

Figure 3 shows the typical structural plan of the repeated floors for the total 20th storey.

Evidently, much progress has been extended in recent years in terms of the studies on the MTMD for mitigating oscillations of structures. However, in most studies on both the TMD and MTMD, it is assumed that a structure vibrates in only one direction or in multiple directions independently with its fundamental modal properties to design the TMD or the MTMD. This assumption simplifies the analysis of a system and the synthesis of a controller. The TMD attached to columns so it will affect the values of the displacements and base shear in each floor level in both direction X and Y (in plan) due to earthquake in direction of EN(X) and SN(Y) as shown in Figure 4.

Table 2. Dimension of reinforced concrete elements of the MRF building (dimension in cm)

Floor	Dimension				
	Columns			Beams	
	C1	C2	C3	B1	B2
1,2,3	70x70	70x70	70x70	25x60	25x60
4,5,6	65x65	65x65	65x65	25x60	25x60
7,8,9	60x60	60x60	60x60	25x60	25x60
10,11,12	55x55	55x55	55x55	25x60	25x60
13,14,15	50x50	50x50	50x50	25x60	25x60
16,17,18	45x45	45x45	45x45	25x60	25x60
19,20	40x40	40x40	40x40	25x60	25x60

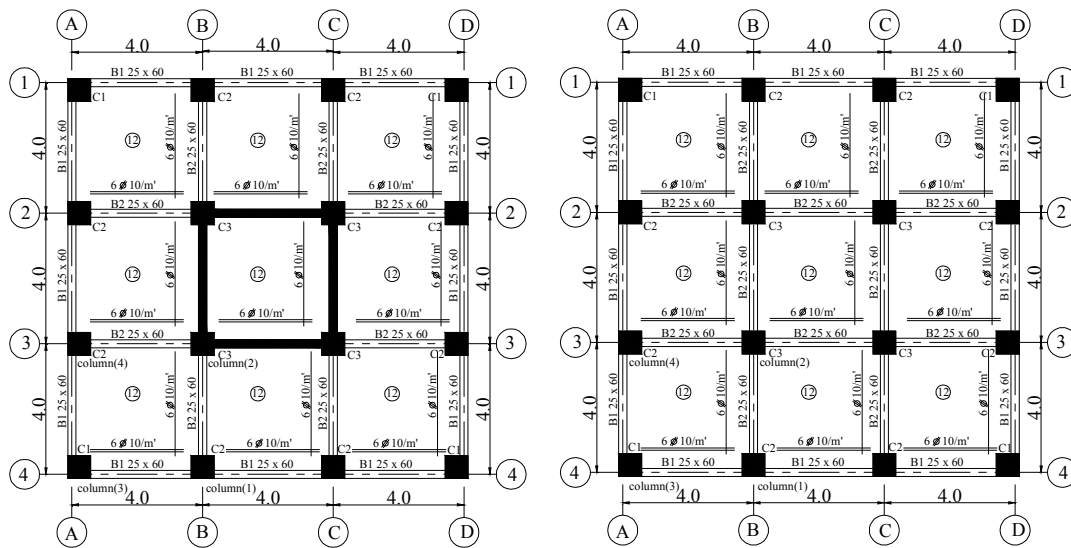

(i) Shear wall model (SW)

(ii) Bar MRF

Figure 3. Typical structural plan of each floor of the 20th storey building model

The objective of this research is to find an alternative method of the traditional method in resisting existing earthquake force, and reducing the response of high tall building subject to earthquake force. To achieve these aims four systems of TMD were applied on the 20th storey MRF with floor height 3m. The first system consists of one TMD composed on each floor as shown in Figure (5-i). Figure (6-i) illustrates the position of one TMD composed on top floor of the building (TMD attached to the column), Figure (6-ii) illustrates 2TMD in 11th and 20th floors, Figure (6-iii) illustrates 4TMD in 3rd, 9th, 15th and 20th floors Figure (6-iv) illustrates

10TMD in staggered for each floor and Figure (6-v) illustrates 20TMD in each floor.

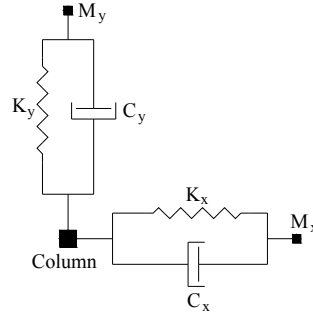
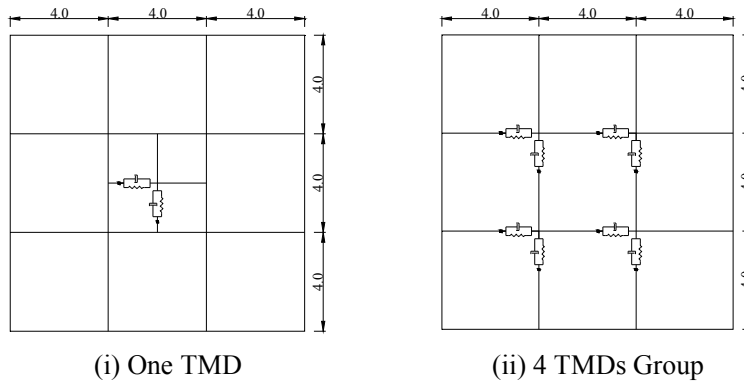

Figure 4. Plan of TMD components in X and Y directions.

The second system consists of a group of four TMDs composed on each floor as shown in Figure (5-ii). Figure (6-i) illustrates the position of one group TMDs composed on top floor of the building (TMD attached to columns), figure (6-ii) illustrates two groups of TMDs in 11th and 20th floors, figure (6-iii) illustrates four groups of TMDs in 3rd, 9th, 15th and 20th floors figure (6-iv) illustrates ten groups of TMDs in staggered for each floor and Figure (6-v) illustrates twenty groups of TMDs in each floor.

The third system consists of a group of eight TMDs composed on each floor as shown in figure (5-iii). Figure (6-i) illustrates the position of one group TMDs composed on top floor of the building (TMD attached to columns), figure (6-ii) illustrates two groups of TMDs in 11th and 20th floors, figure (6-iii) illustrates four groups of TMDs in 3rd, 9th, 15th and 20th floors figure (6-iv) illustrates ten groups of TMDs in staggered for each floor and figure (6-v) illustrates twenty groups of TMDs in each floor.

The fourth system consists of a group of sixteen TMDs composed on each floor as shown in figure (5-iv). Figure (6-i) illustrates the position of one group TMDs composed on top floor of the building (TMD attached to columns), figure (6-ii) illustrates two groups of TMDs in 11th and 20th floors, figure (6-iii) illustrates four groups of TMDs in 3rd, 9th, 15th and 20th floors figure (6-iv) illustrates ten groups of TMDs in staggered for each floor and Figure (6-v) illustrates twenty groups of TMDs in each floor.



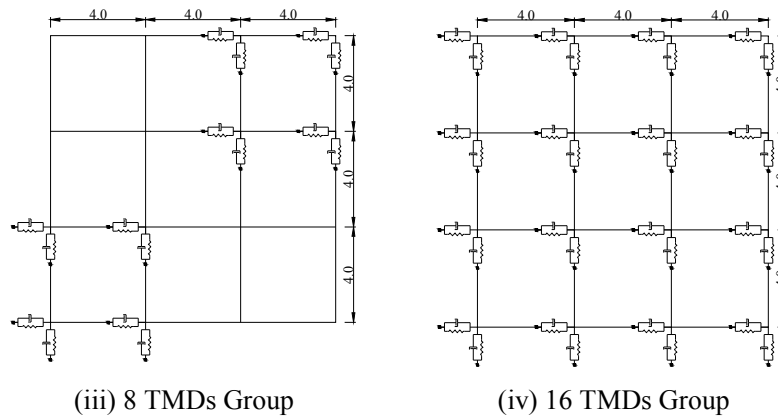

Figure 5. Horizontal arrangement of TMDs on floor plan

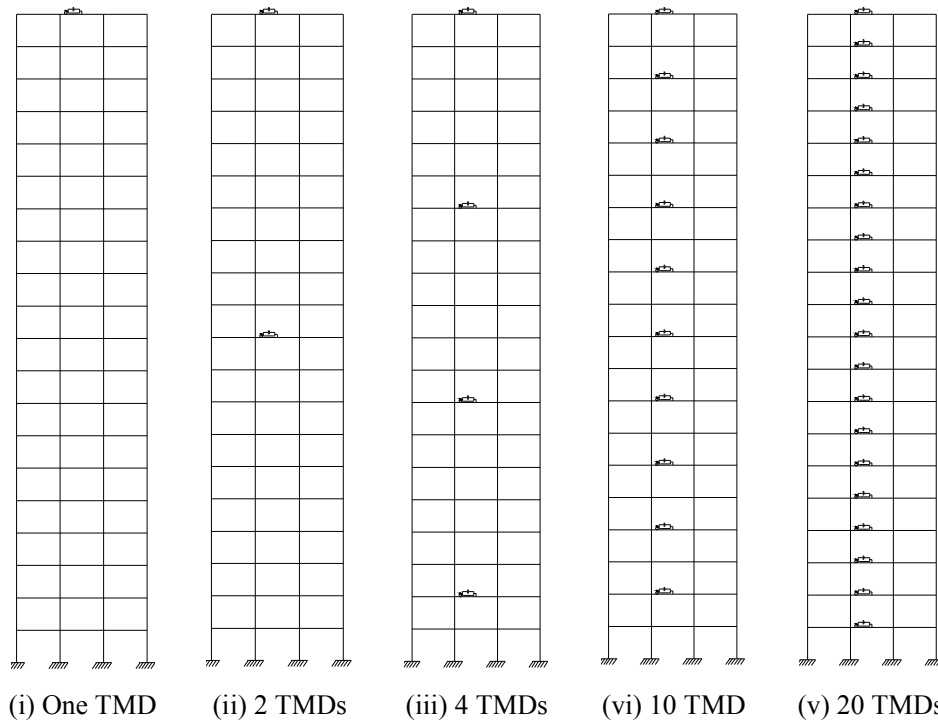

Figure 6. Vertical arrangement of TMDs on model elevation

The models, with and without TMDs, have been tested using CSI SAP2000 computer program. The tested models are tested with 3D frame structure using frame elements for columns, longitudinal beams, while the TMDs are tested using link elements for springs and dashpots.

Table 3 illustrates values of the optimum parameters (spring stiffness k_d , damping coefficient of damper c_d , and relative damping ζ_{opt}) of several numbers of TMDs. For single

TMD used in the model the numbers are 1, 2, 4, 10, and 20 distributed on each floor level. For 4th TMDs disabused on the plane of the model, (4 on each floor) group of TMDs contains 4 TMDs are $4 \times 1=4$, $4 \times 2=8$, $4 \times 5=20$, $4 \times 10=40$ and $4 \times 20=80$. For 16th TMDs groups disabused on the plane of the model, (16 on each floor for each column) group of TMDs contains 16 TMDs are $16 \times 1=16$, $16 \times 2=32$, $16 \times 5=80$, $16 \times 10=160$ and $16 \times 20=320$.

Table 3. Properties of TMDs used in the testing models in both X, Y directions as Zahrai and ghannadi-Asl [16].

No. TMDs	m_{TMD} (ton)	$\mu\%$	α_{opt}	ζ_{opt}	k_d	c_d
1	216	0.050	0.940	0.051	152.789	83.029
2	108	0.025	0.970	0.026	40.597	21.797
4	54	0.013	0.985	0.013	10.467	5.586
8	27	0.006	0.992	0.007	2.658	1.414
10	21.6	0.005	0.994	0.005	1.706	0.907
16	13.5	0.003	0.996	0.003	0.670	0.356
20	10.8	0.002	0.997	0.003	0.429	0.228
32	6.75	0.002	0.998	0.002	0.168	0.089
40	5.4	0.001	0.998	0.001	0.108	0.057
80	2.7	0.001	0.999	0.001	0.027	0.014
160	1.35	0.000	1.000	0.000	0.007	0.004
320	0.68	0.000	1.000	0.000	0.002	0.001

4. ASSUMPTIONS

The following assumptions were taking into account in the testing process:

- i. Column sizes from the first floor to the top are of the variable (get smaller) size as shown in table 2.
- ii. Stiffness of floor slabs, beams and columns of the frame make a rigid diaphragm in horizontal plan.
- iii. The frames have been modelled as rigid frames, (the connection between radial beams to the core are pinned)
- iv. All restrains that have been modelled are assumed to be fixed.
- v. Only ground acceleration of X and Y directions are taken into account.

5. RESULTS AND DISCUSSION

Figure 7 shows the results of displacements of each floor under seismic load using several arrangements of TMDs. For all systems the ratios between displacements of model without and with shear wall are nearly 2 from 3rd to 30th floors and 1.1 from 33rd to 60th floors. The high performance of the arrangement group in reducing displacements of floors appears in 16×20 TMDs then 16×10 , 8×20 , 16×7 , 8×10 , 4×20 , 16×5 , 16×4 , 4×10 , 8×4 , 16×2 , 4×5 , 20,

8x2, 4, 10, 4x2, 2, 4x1, 1, 16x1, 8x1 TMDs. Table 4 shows the comparison of the displacement values of each system.

Table 4. Displacements ratios between bar MRF, shear wall models and TMD group systems.

System	One TMD					Four TMD				
	1	2	4	10	20	1	2	4	10	20
Bar MRF	26	32	43	42	50	32	37	56	65	77
Sw	0.4	8	22	22	36	6	14	38	49	66

System	Eight TMD					Sixteen TMD				
	1	2	4	10	20	1	2	4	10	20
Bar MRF	16	49	61	78	88	19	58	67	88	92
Sw	9	30	44	67	82	11	43	51	67	74

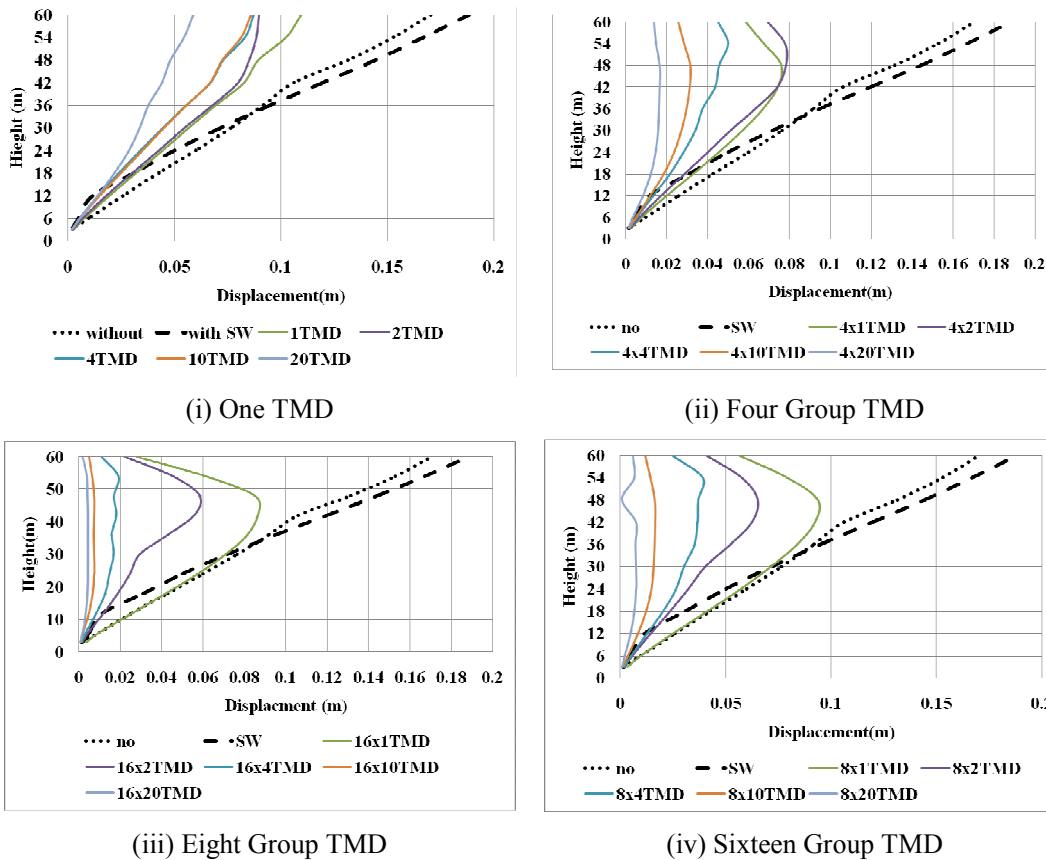

Figure 7. Comparison of displacements of the model under seismic load with different

arrangements of TMDs

Figure 8 shows the results of column shear forces in each floor under seismic load using several arrangements of TMDs. Figure (8-a) shows shear force of columns (1), the ratios between base shear force of model without and with shear wall is nearly 2.4. Figure (8-b) shows shear force of columns (2), the shear wall model reduces base shear of column (2) by nearly 2.64 times. Figure (8-c) shows shear force for columns (3), the shear wall model reduces base shear of column (3) by nearly 1.85 times. Figure (8-d) shows shear force for columns (4), shear wall model reduce base shear of column (4) by nearly 1.53 times. Table 5 shows the comparison of the displacement values of each system. Table (5-i) illustrates the ratios of base shear for column (1). Table (5-ii) illustrates the ratios of base shear for column (2). Table (5-iii) illustrates the ratios of base shear for column (3). Table (5-iv) illustrates the ratios of base shear for column (4).

Table 5. Shear forces ratios between bar MRF, shear wall models and TMD group systems
i) Column (1)

System	One TMD/floor					Four TMD/floor				
	1	2	4	10	20	1	2	4	10	20
Bar MRF	23	35	47	49	60	29	43	59	69	82
S w	-6	2	21	33	36	-2	15	37	50	70
System	Eight TMD/floor					Sixteen TMD/floor				
	1	2	4	10	20	1	2	4	10	20
Bar MRF	23	46	64	75	83	8	43	72	85	89
S w	-5	19	44	61	74	5	14	58	77	82

Positive singes indicate reduction, negative singes indicate increase

ii) Column (2)

System	One TMD/floor					Four TMD/floor				
	1	2	4	10	20	1	2	4	10	20
Bar MRF	20	31	44	47	60	26	40	58	70	84
Sw	-182	-171	-136	-144	-133	-191	-162	-134	-123	11
System	Eight TMD/floor					Sixteen TMD/floor				
	1	2	4	10	20	1	2	4	10	20
Bar MRF	22	44	64	75	83	7	40	70	83	92
Sw	-240	-139	7	12	47	-242	-119	10	29	46

Positive sings indicate reduction, negative sings indicate increase
iii) Column (3)

System	One TMD/floor					Four TMD/floor				
	1	2	4	10	20	1	2	4	10	20
Bar MRF	23	33	47	47	58	27	40	54	64	77
Sw	4	15	34	32	44	9	24	42	53	69
System	Eight TMD/floor					Sixteen TMD/floor				
	1	2	4	10	20	1	2	4	10	20
Bar MRF	22	41	57	71	80	6	35	64	76	82
S w	1	28	46	62	75	1	22	57	71	77

Positive sings indicate reduction, negative sings indicate increase
iv) Column (4)

System	One TMD/floor					Four TMD/floor				
	1	2	4	10	20	1	2	4	10	20
Bar MRF	18	29	41	44	56	25	35	53	65	82
Sw	30	39	50	51	60	37	45	59	67	82
System	Eight TMD/floor					Sixteen TMD/floor				
	1	2	4	10	20	1	2	4	10	20
Bar MRF	18	38	54	67	79	1	31	61	73	83
S w	28	47	60	71	81	16	44	68	77	87

Positive sings indicate reduction, negative sings indicate increase

The performance of TMDs group arrangements in reducing shear force for column (1) is in sequence 20x16, 10x16, 20x8, 20x4, 10x8, 5x16, 10x4, 4x8, 4x5, 20, 10, 4, 2, 4, 2x16, 2x8, 2, 1x4, 1, 1x8, and 1x16. The performance of TMDs group arrangements in reducing shear force for column (2) is on sequence 20x16, 20x4, 10x16, 20x8, 10x8, 10x4, 5x16, 20, 4x5, 4x8, 4x16, 10 4, 2x4, 2x8, 2, 2x16, 1x4, 1, 1x8 and 1x16. The performance of TMDs group arrangements in reducing shear force for column (3) is in sequence 20x16, 20x8, 10x16, 20x4, 7x16, 10x8, 5x16, 10x4, 20, 4x16, 4x8, 4x5, 4, 10, 2x4, 2x16, 2x8, 2, 1x4, 1, 1x8, and 1x16. The performance of TMDs group arrangements in reducing the shear force of column (4) is in sequence 20x16, 20x4, 20x8, 10x16, 10x8, 5x16, 10x4, 20, 4x5, 4x16, 4x8, 10, 4, 2x4, 2x8, 2x16, 2, 1x4, 1, 1x8, and 1x16.

Arrangements of TMDs in floor plan (especially ones attached to columns) reduce the displacement in a very effectiveness the distribution of TMDs with columns places distribute the vibration forces on each TMD to reduce these effects and reduce shear force on each column. Lateral effect of seismic vibration distributed on vertical elements of the

building (i. e. columns) with a ratio of inertia of each element (equal inertia in this case) so, the attachment of TMDs devices on each column of the model or some numbers of the column will affect considerably on reduction vibration of the model so that, the values of total displacements and shear forces in columns each floor.

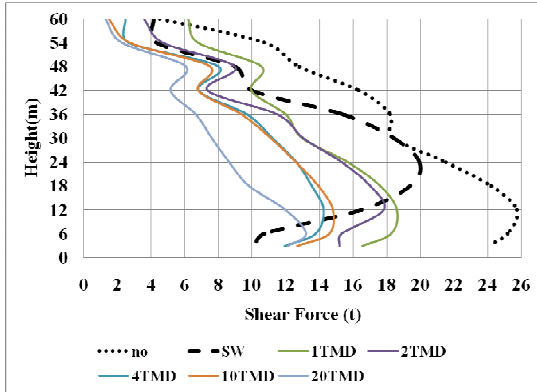

(i) One TMD

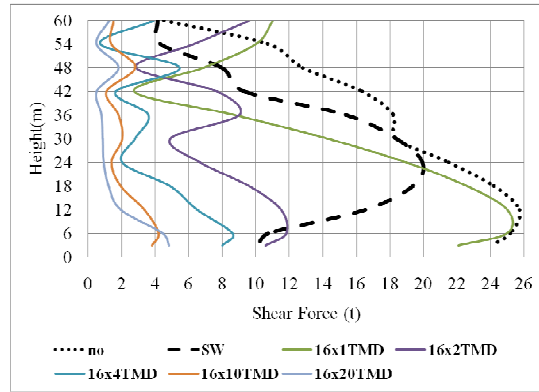

(ii) Four Group TMD

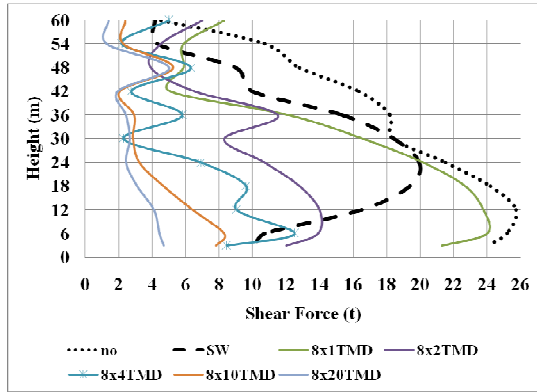

(iii) Eight Group TMD

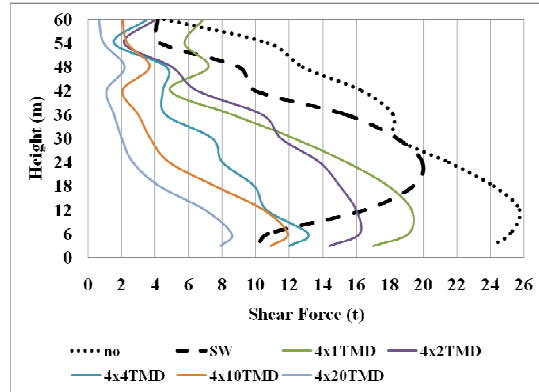

(iv) Sixteen Group TMD

(a) Shear force column (1)

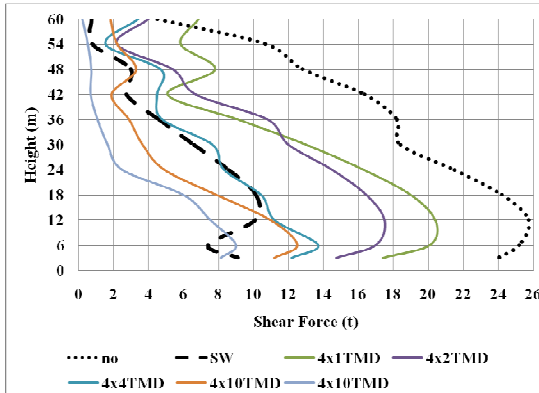
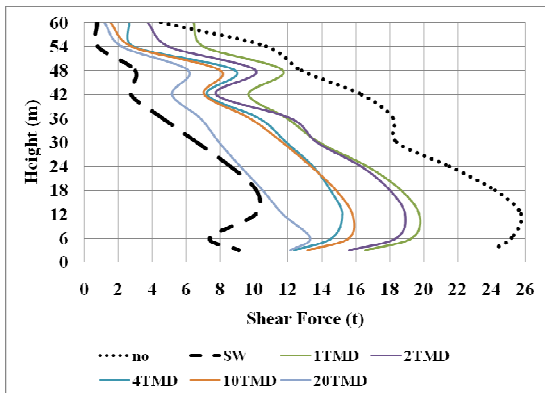

(i) One TMD

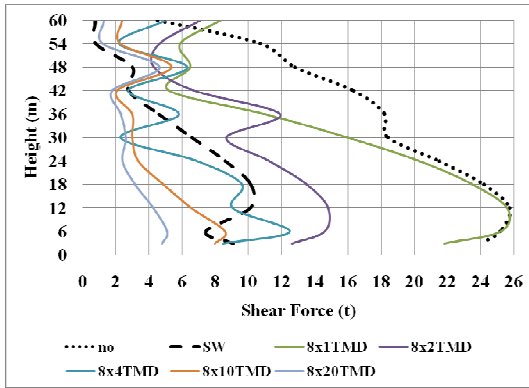

(ii) Group 4 TMD

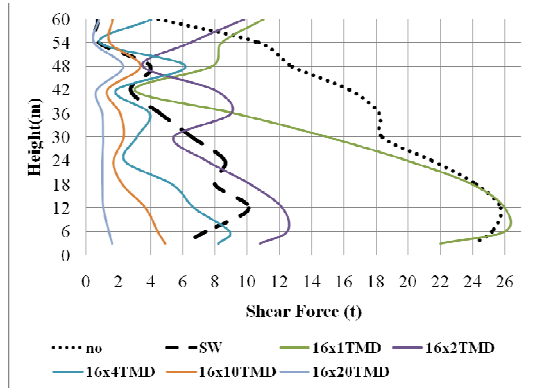

(iii) Group 8 TMD

(b) Shear force column (2)

(iv) Group 16 TMD

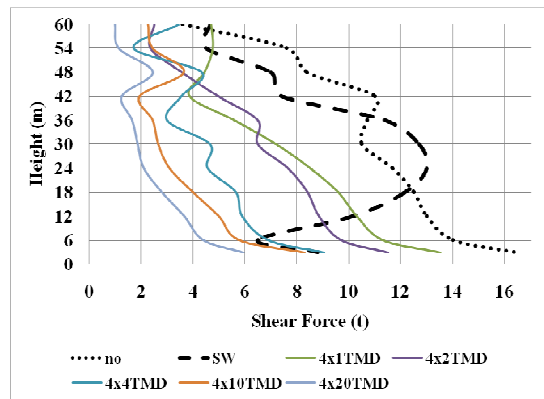
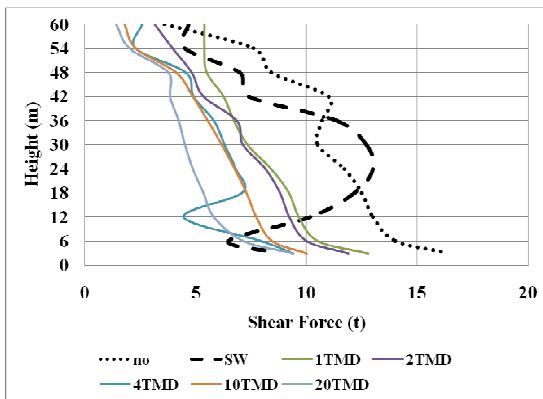

(i) One TMD

(ii) Four Group TMD

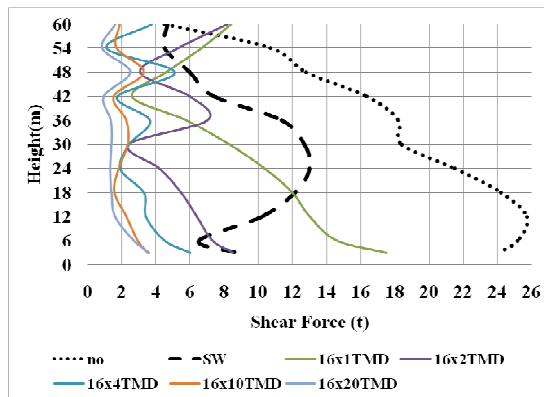
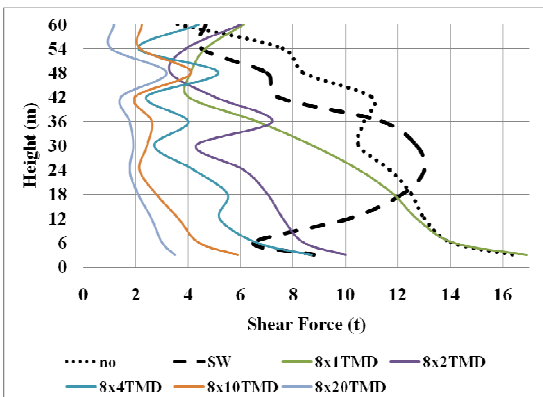

(ii) Eight Group TMD

(iv) Sixteen Group TMD

(c) Shear force column (3)

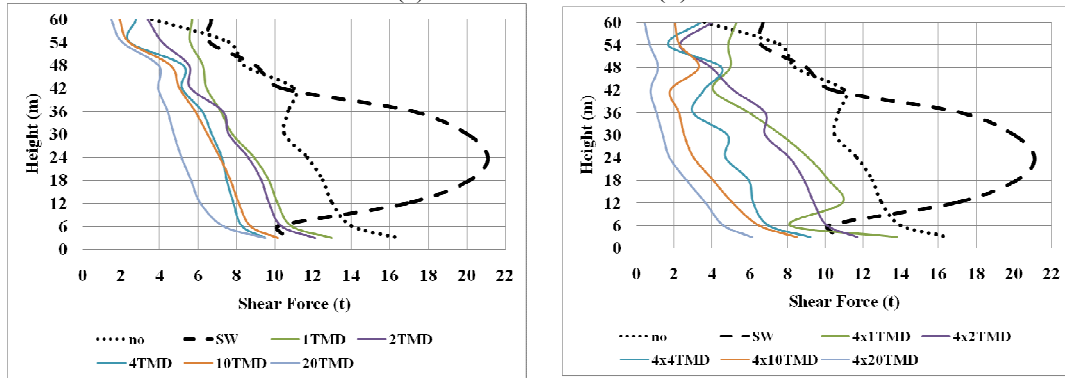

(i) One TMD

(ii) Four Group TMD

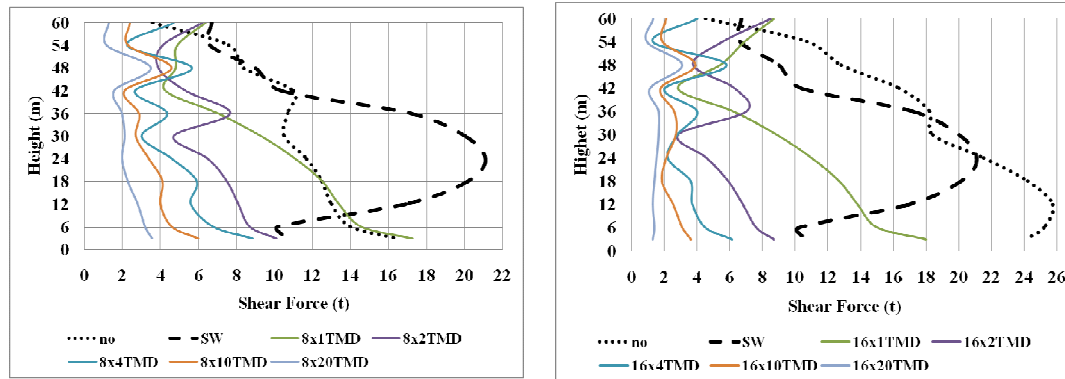

(iii) Eight Group TMD

(iv) Sixteen Group TMD

(d) Shear force of column (4)

Figure 8. Comparison of shear forces of the model under Seismic load with different arrangements of TMDs

Figure 9 illustrates the displacements vs. the base shear force of the models using different arrangements of TMDs groups. From figures, use the single TMD in the model creates a disturbance shape of the relation between displacements and base shear forces. Single TMD distributed through the elevation of the model create a more un-disturbance relation between displacements and base shear forces. The one Group of TMDs (4, 8, 16 TMDs) in the top model will reduce the disturbance of the relation between top displacements and base shear forces. Groups of TMDs distributed on the floor plane of the model and through the elevation of the model show nearly a linear relation between the displacements of top model and the base shear forces. The above discusses show that increase number of TMDs distributed on the floor plane of model will decrease the vibration of model results from seismic waves especially those distributed both in floor plan and through the elevation of the model.

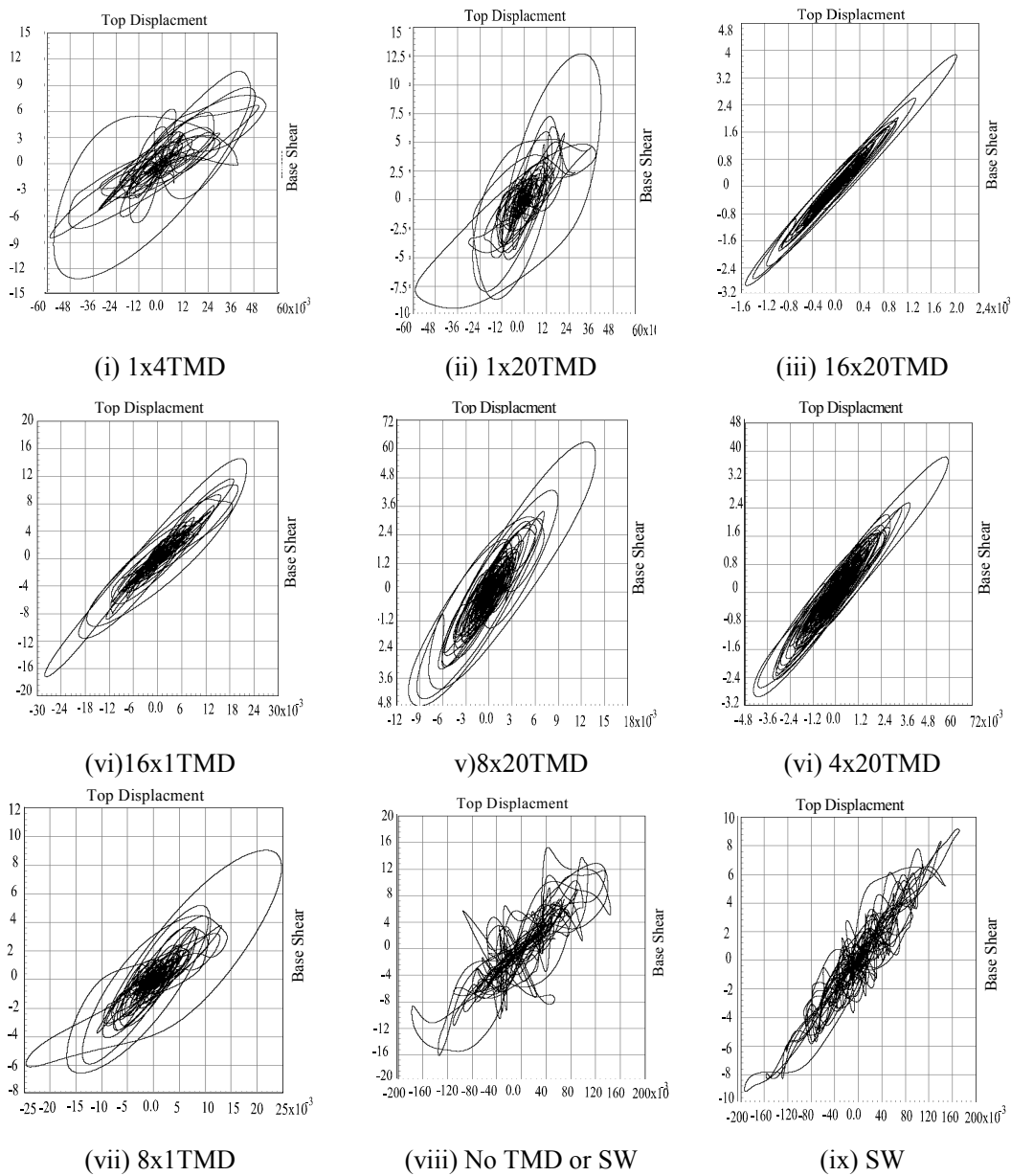
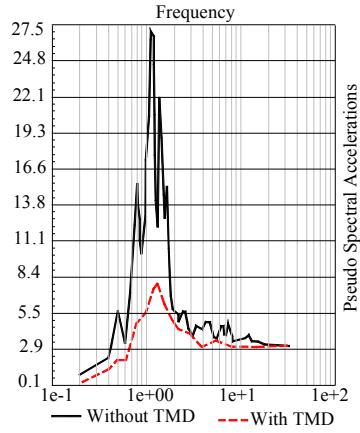

Figure 9. Trajectories of base shear and displacements with and without use TMDs

Figure 10 shows the frequency of the top point of the free and under varies cases of using shear wall, single TMD and group of TMDs models. The frequency in both cases free and shear wall models is nearly equal (4 Hz) and the acceleration also nearly equals (11.8 m/s²) but the values of frequency in the models used TMDs especially a group of TMDs is reduced by nearly 2.5 times and the acceleration by nearly 4 times. The frequency when

using a group of TMDs in the model shows a wide board frequency for the model.



(i) 1x20TMD

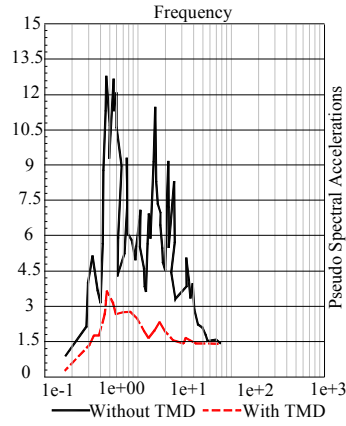

(ii) 1x16TMD

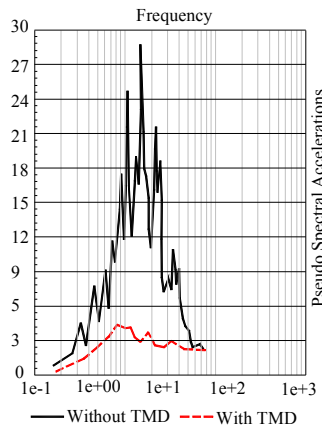

(iii) 16x20TMD

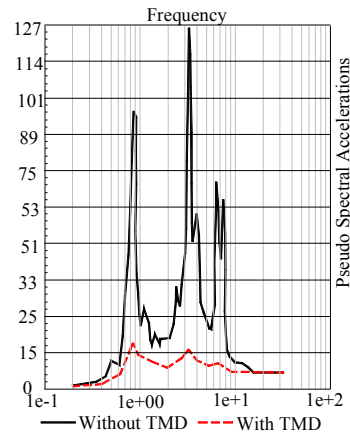

(iv) SW only

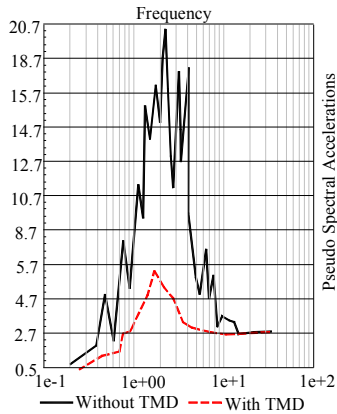

(v) 4x20TMD

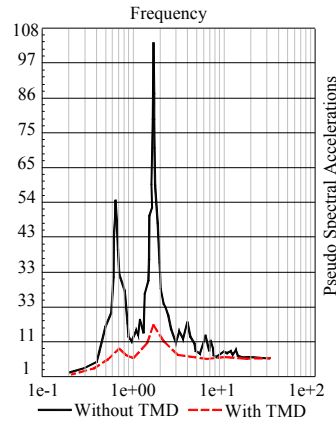

(vi) No TMD and SW

Figure 10. Frequency vs. pseudo acceleration spectral

Figure 11 illustrates the comparison of vibration of displacements and shear force of the models with and without using TMDs. The vibration of the top displacements and base shear of the model use TMD shown in the figures in light colors. Figure (11-a left) shows the effect of use 4 single TMDs in the model on reduction of the displacements of shear wall (sw) model and Figure (11-a right) shows the effect of use 4 single TMDs in the model on base shear with respect to sw model, the effect on base shear show nearly both vibration are equals. Figure (11-b right) shows the effect of use group 4 TMDs (distributed on floor plan) in the model on reduction of the displacements of free model and Figure (11-b left) shows the effect of use group 4 TMDs in the model on base shear with respect to free model, the effect on base shear show nearly both vibration are equals. Figure (11-c left) shows the effect of use group 4x20 TMDs (distributed on floor plan through the model) in the model on reduction of the displacements of sw model and Figure (11-c right) shows the effect of use group 4x20 TMDs in the model on base shear with respect to sw model, the effect on base shear show vibration of TMDs group reduced by nearly 2.5 times than sw model. Figure (11-d left) shows the effect of use group 8x20 TMDs (distributed on floor plan through the model) in the model on reduction of the displacements of sw model and Figure (11-d right) shows the effect of use group 8x20 TMDs in the model on base shear with respect to sw model, the effect on base shear show vibration of TMDs group reduced by nearly 3 times than sw model.

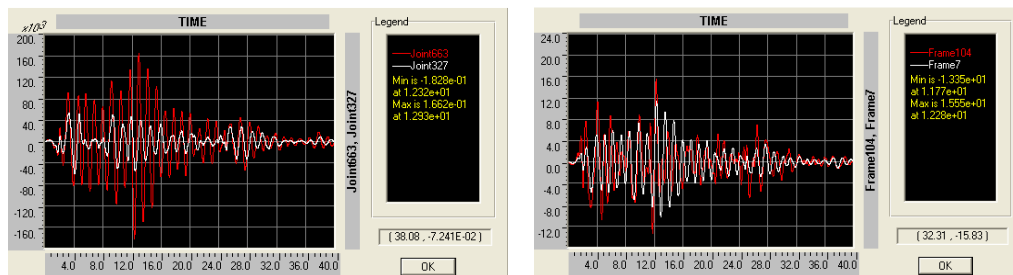

Displacement

Base shear

(a) Comparison of 4 TMDs on floor plan and SW model

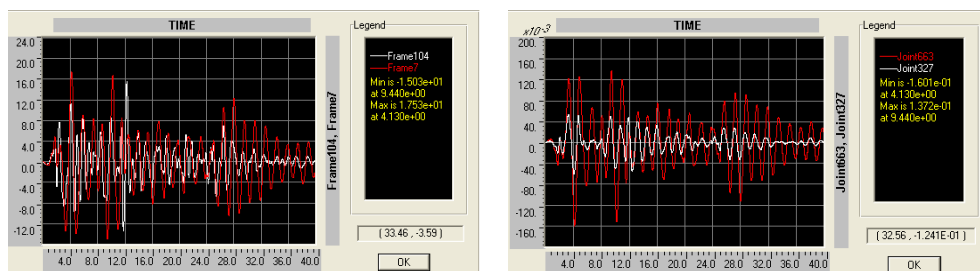

Base shear

Displacement

(b) Comparison between 4x1TMDs on elevation and free model

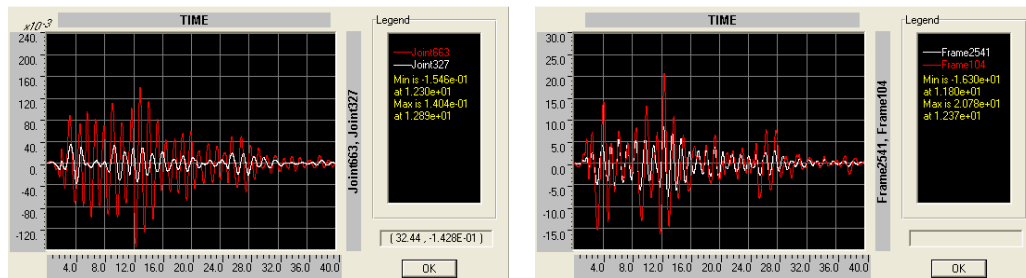

Displacement

Base shear

(c) Comparison between 4x20TMDs distributed on floor plan and elevation and SW model

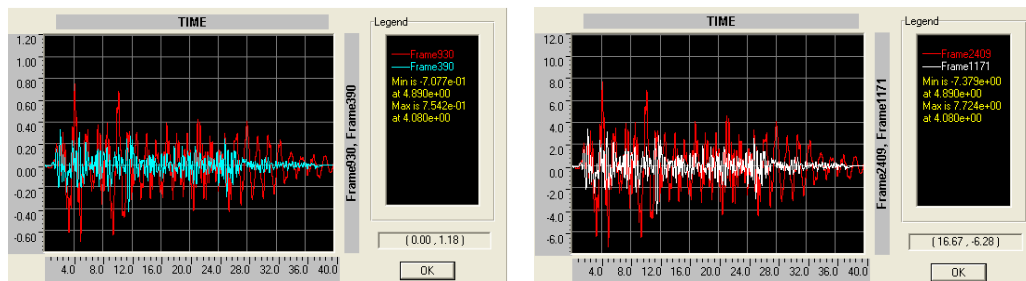

Base shear col (2)

Base shear col (1)

(d) Comparison between 8x20TMDs distributed on floor plan and elevation and SW model

Figure 11. Comparison between the vibrations of top point displacement and base shear force in model with and without TMDs

6. CONCLUSION

The present paper studies the seismic behaviour on tall buildings structure through using the TMD system. The TMDs devices has showed energy dissipation by different models systems and easy to install with.

The following conclusions can be drawn from the present study:

1. The response of structures can be dramatically reduced by using TMD and significantly decrease in shear forces.
2. One of the more significant findings to emerge from this study is that, with increasing the amount of dynamic amplitude, the reduction percentage of response of structures due to applying TMDs has been raised too. In other words, it can be understood that, whatever the amount of dynamic amplitude is increased, the performance of TMDs is much better.
3. Single TMD distributed through the elevation of the model is better than using only in the top of the model. This will reduce both overall displacements and base shear forces especially when use sw.
4. Using group of TMDs distributed on the floor plan of the model will more effect the

reduction of displacements and shear force especially those how distributed in the elevation of the model which will be the solution of resist earthquake completely for both undesirable effects of it (large displacements and shear force in columns).

5. Group 16 TMDs are very effective for reducing both displacements and shear force than any lateral resistance method but it is uneconomic, using group 4 TMDs distributed on floor plan staggered through the elevation of the model give better results than SW model and more economic.

The optimum distribution of TMDs is on the floor plan of the buildings and through the elevation to control the vibration in each floor level effectively.

Finally, recommendations for the future research in the field of applying TMD is on an experimentally model using shaking table to validate the results of using TMD in reducing both displacements and shear forces in the high rise buildings.

REFERENCES

1. Den Hartog JP. *Mechanical Vibrations*, 4th Ed, McGraw-Hill, New York, 1956.
2. Webster AC, Vaicaitis R. Application of Tuned Mass Dampers to Control Vibrations of Composite Floor Systems. *Engineering Journal, American Institute of Steel Construction*, Third Quarter, 1992; pp. 116–124.
3. Al-Hulwah KI. Floor Vibration Control Using Three Degree of Freedom Tuned Mass Dampers, The School of Engineering, University of Dayton. Ph.D. thesis, 2005.
4. Smith JW. *Vibration of Structures Application in Civil Engineering Design*, Chapman and Hall, New York, 1988.
5. An-Pei W, Yung-Hing L. Vibration control of a tall building subjected to earthquake excitation. *J Sound Vib*, 2007; **299**: 757-73.
6. Semih S, Ozan U. Reduction of earthquake response of plane frame buildings by viscoelastic dampers. *J Struct Eng ASCE* 2003; **25**: 1755–61.
7. Iwanami K, Seto K. Optimum design of dual tuned mass dampers and their effectiveness. *Proc JSME(C)*, 1984; **50**(449): 44–52 [in Japanese].
8. Igusa T, Xu K. Vibration control using multiple tuned mass dampers. *J Sound Vib*, 1994; **175**(4): 491–503.
9. Li C. Optimum multiple tuned mass dampers for structures under the ground acceleration based on DDMF and ADMF. *J Earthquake Eng Struct Dyn* 2002; **31**: 897–919.
10. Li C. Optimum multiple tuned mass dampers for structures under the ground acceleration based on DDMF and ADMF. *J Earthquake Eng Struct* 2002; **31**:897–919.
11. Li C, Liu Y. Further characteristics for multiple tuned mass dampers. *J Struct Eng ASCE* 2002; **128**(10): 1362–5.
12. Li C, Liu Y. Optimum multiple tuned mass dampers for structures under the ground acceleration based on the uniform distribution of system parameters. *J Earthquake Eng Struct Dyn* 2003; **32**: 671–90.

13. Sadek F, Mohraz B, Taylor AW, Chung RM. A method of estimating the parameters of tuned mass dampers for seismic applications, *J Earthquake Eng Struct Dyn* 1997; **26**: 617–35.
14. Villaverde R. Reduction in seismic response with heavily damped vibration absorbers, *J Earthquake Eng Struct Dyn*, 1988; **13**(1985): 33–42.
15. Bath KJ. *Finite Element Procedures*. Prentice-Hall, Englewood Cliffs, NJ. 1996.
16. Zahrai SM, Ghannadi-Asl A. Seismic performance of TMDs in improving the response of MRF buildings, *Scientia Iranica*, 2008; **13**: 21-33.

NOMENCLATURE

TMD	Tuned mass damper
MRF	Moment resistance frame
m_1	Mass of the floor
m_2	Mass of tuned mass damper
k_1	Spring stiffness of the floor
k_2	Spring stiffness of the tuned mass damper
c_1	Damping of the floor
c_2	Damping of the tuned mass damper
x_1	Displacement of m_1
x_2	Displacement of m_2
$F(t)$	Force excitation
f	Frequency
f_1	Lower frequency of system
f_2	Higher frequency of system
f_n	Natural frequency of system
f_d	Natural damper frequency
f_s	Steel stress
f_c	Concrete stress
sw	Shear wall

GREEK SYMBOLS

μ	Mass ratio
α	Frequency ratio
α_{opt}	Optimum frequency ratio
ζ	Damping ratio
ζ_{opt}	Optimum damping ratio
Φ	Amplitude of the first mode of vibration
β	Damping ratio (first mode)